

Wardrobe Suites

SECTION NUMBER	DESCRIPTION	MASS kg/m	OUTSIDE PERIM
33947 [!]	Fixing Rail	0.474	118.61
33952	Top Track	0.293	167.68
33953	Double Top Track	0.587	280.10
33954	Triple Top Track	0.880	392.51
33956	Bottom Track	0.382	205.55
33957	Bottom Track	0.543	290.37
33958	Top Rail	0.391	140.03
33959	Bottom Rail	0.592	292.46
33960~	Stile	0.516	199.03
34069 ⁺	Euro Hanging Rail	0.459	91.18
36157 ⁺	Wardrobe Hanging Rail	0.310	76.58
9250	Top Track	0.431	246.63
9251	Bottom Track	0.217	136.10
N923	Bottom Track	0.370	230.10
N924	Top Track	0.745	409.90
Z439	Top and Bottom Rail	0.285	106.40
Z447 [*]	Stile	0.282	165.46
K068	Wardrobe Rail	0.564	266.60

~ Also available in anodised 4.8m lengths

* Available in 4.8m lengths only

+ Available in anodised only

! Also available in white satin

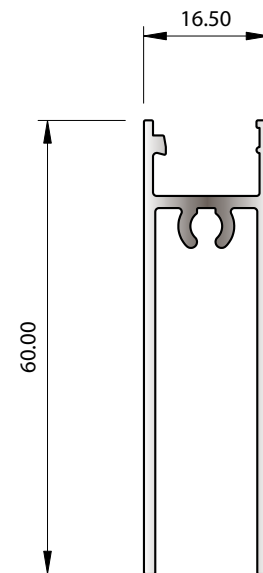

SECTION No. 33959

0.592 kg/m

P = 292.46

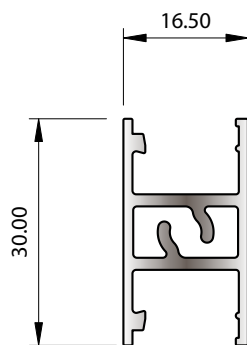

SECTION No. 33958

0.391 kg/m

P = 140.03

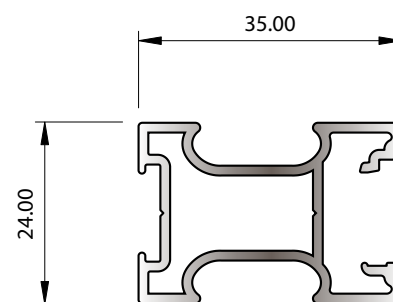

SECTION No. 33960

0.516 kg/m

P = 199.03

For NZ based customers. All lengths are stocked in 6060 T5 - mill finish - 5m lengths (unless specified)
All peripheries less than 100mm are deemed 100mm for surface finish purpose

Wardrobe Suites

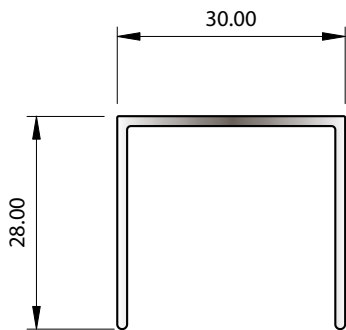
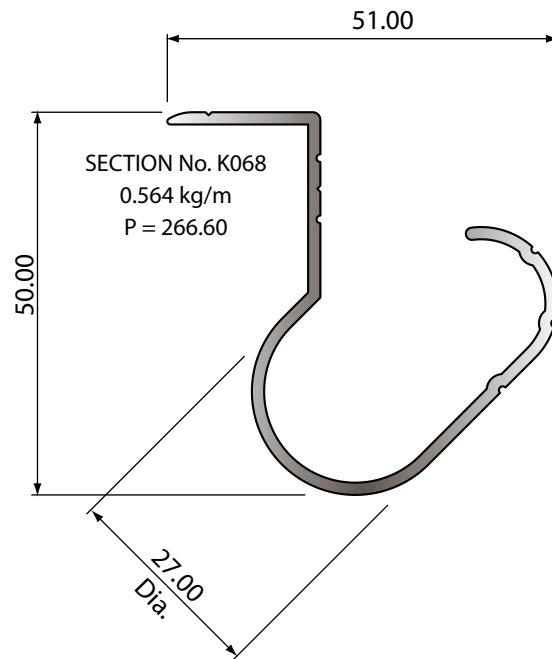

SECTION No. 33952
0.293 kg/m
P = 167.68

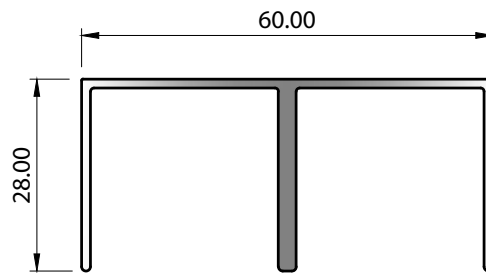

SECTION No. 33953
0.587 kg/m
P = 280.10

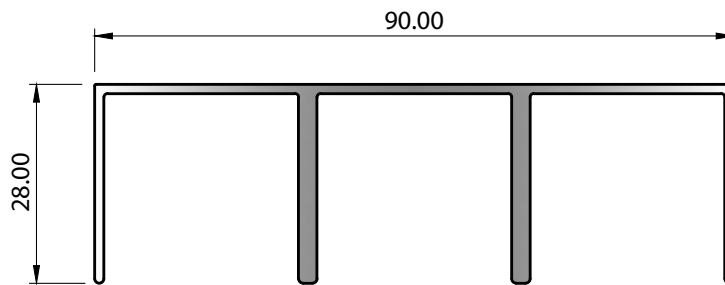

SECTION No. 33954
0.880 kg/m
P = 392.51

For NZ based customers. All lengths are stocked in 6060 T5 - mill finish - 5m lengths (unless specified)
All peripheries less than 100mm are deemed 100mm for surface finish purpose

Wardrobe Suites

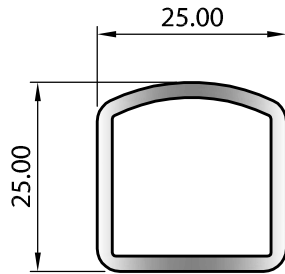

SECTION No. 34069
0.459 kg/m
P = 91.18

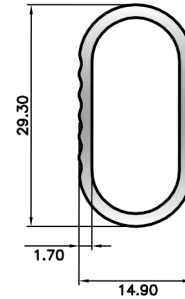

SECTION No. 36157
0.310 kg/m
P = 76.58

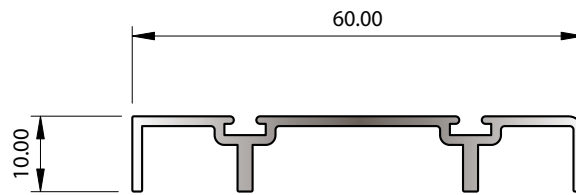

SECTION No. 33956
0.382 kg/m
P = 205.55

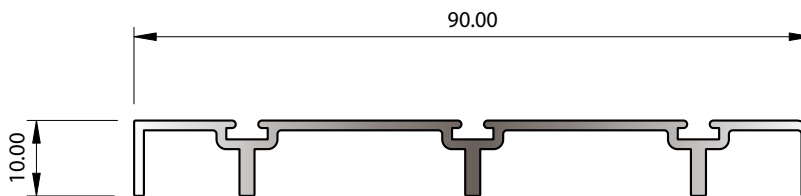

SECTION No. 33957
0.543 kg/m
P = 290.37

For NZ based customers. All lengths are stocked in 6060 T5 - mill finish - 5m lengths (unless specified)
All peripheries less than 100mm are deemed 100mm for surface finish purpose

Wardrobe Suites

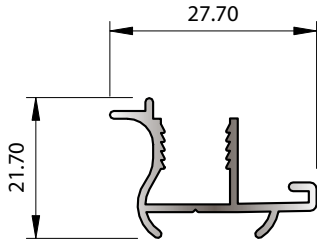

SECTION No. Z447
0.282 kg/m
P = 165.46

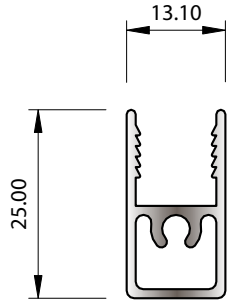

SECTION No. Z439
0.285 kg/m
P = 106.40

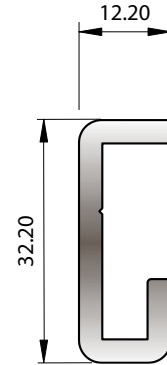

SECTION No. 33947
0.474 kg/m
P = 118.61

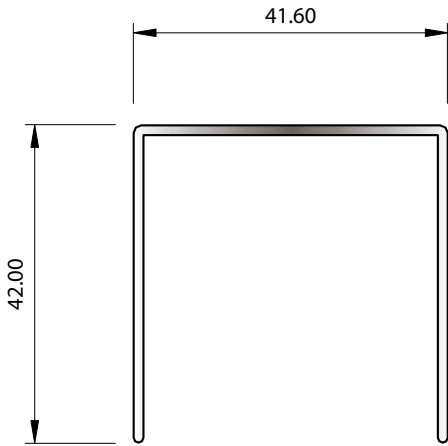

SECTION No. 9250
0.431 kg/m
P = 246.63

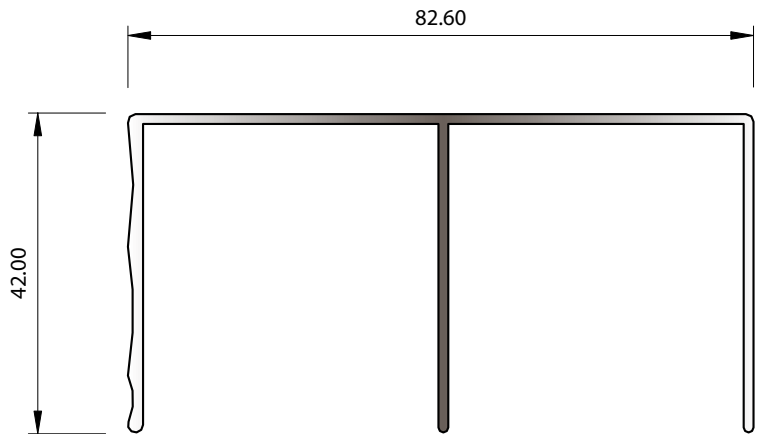

SECTION No. N924
0.745 kg/m
P = 409.90

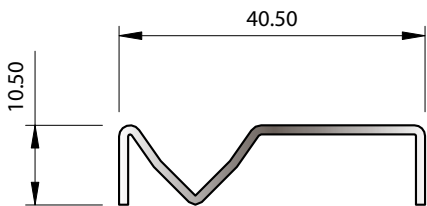

SECTION No. 9251
0.217 kg/m
P = 136.10

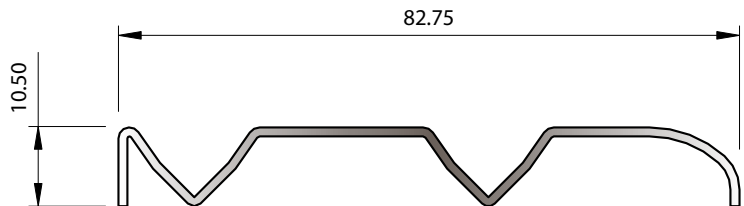

SECTION No. N923
0.370 kg/m
P = 230.10

For NZ based customers. All lengths are stocked in 6060 T5 - mill finish - 5m lengths (unless specified)
All peripheries less than 100mm are deemed 100mm for surface finish purpose